

6.2 CS-MTZ16CKE

<Top View>

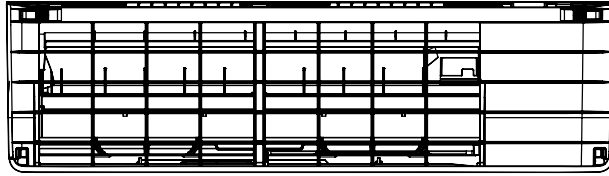

<Side View>

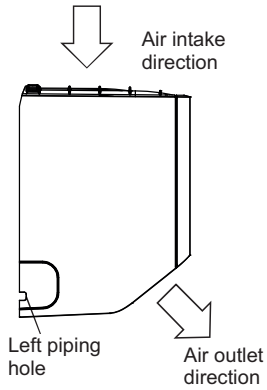

<Front View>

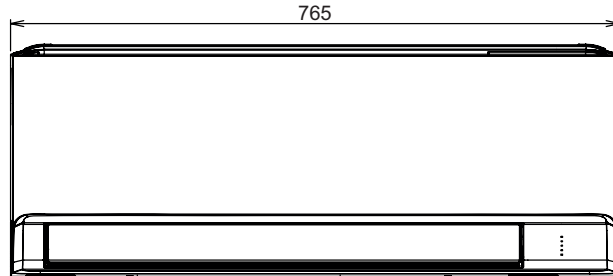

<Side View>

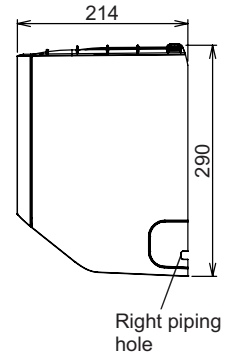

<Bottom View>

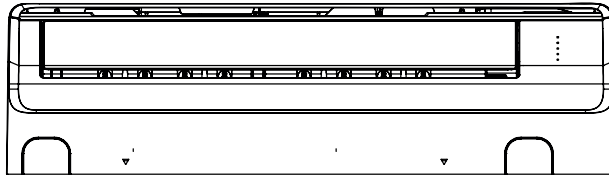

<Remote Control>



<Rear View>

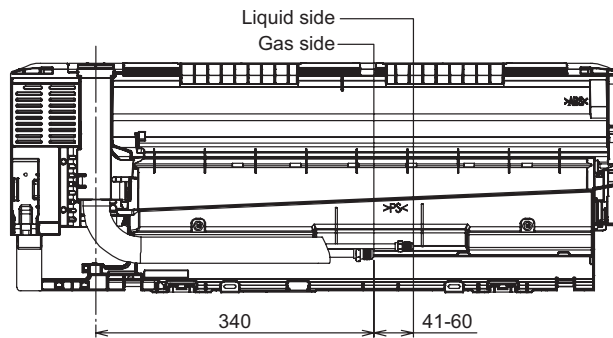

<Remote Control Holder>

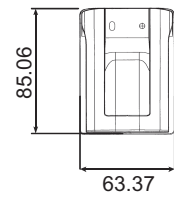

Relative position between the indoor unit and the installation plate <Front View>

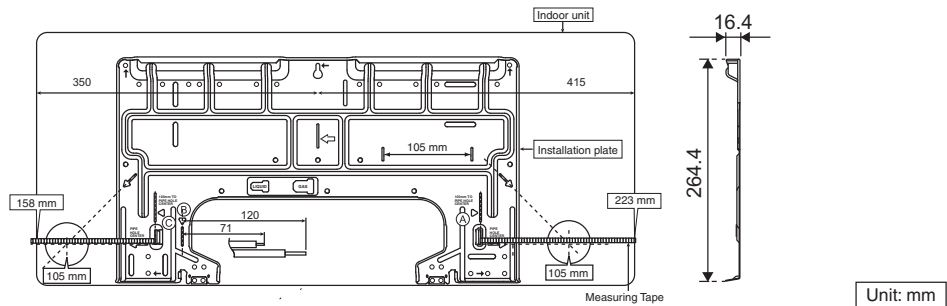

6. Dimensions

6.1 Indoor Unit

6.1.1 CS-TZ20CKEW CS-TZ25CKEW CS-TZ35CKEW CS-TZ42CKEW CS-TZ50CKEW CS-RZ25CKEW CS-RZ35CKEW CS-RZ50CKEW

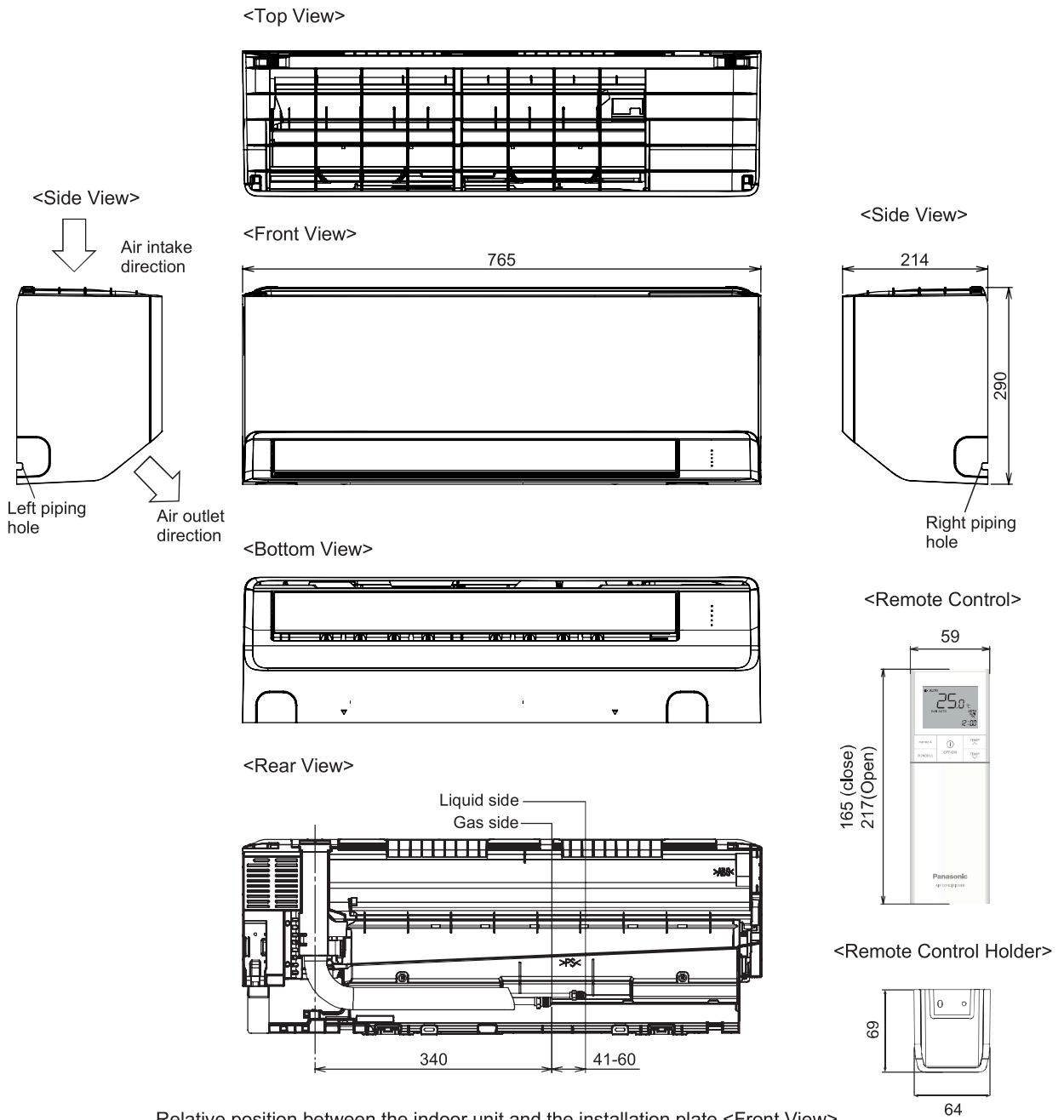

Relative position between the indoor unit and the installation plate <Front View>

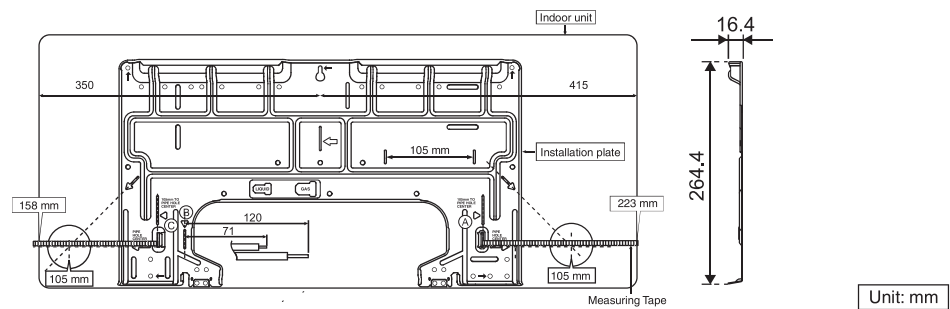

6.1.2 CS-TZ60CKEW CS-TZ71CKEW

<Top View>

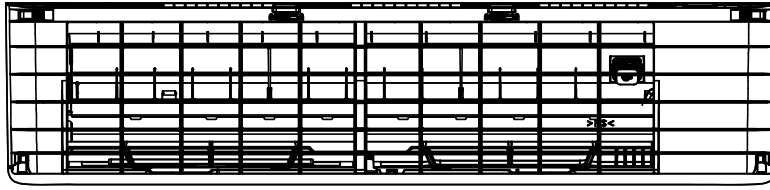

<Side View>

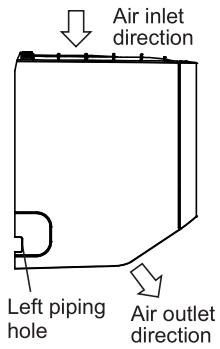

<Front View>

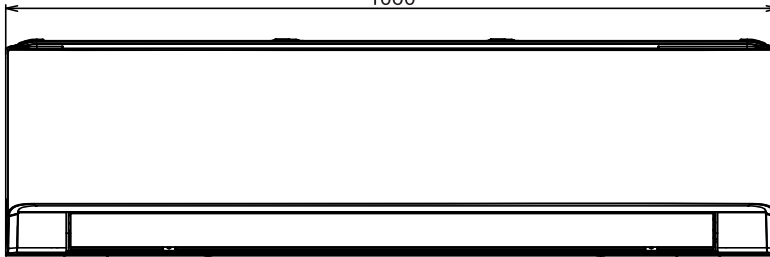

<Side View>

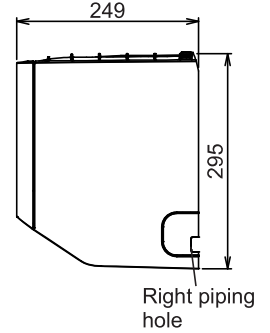

<Bottom View>

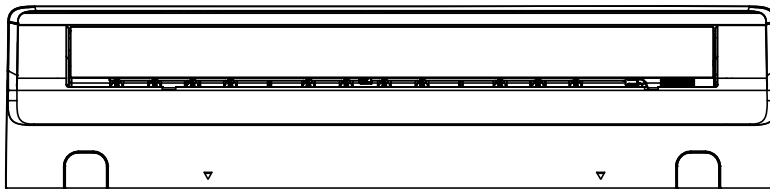

<Remote Control>



<Rear View>

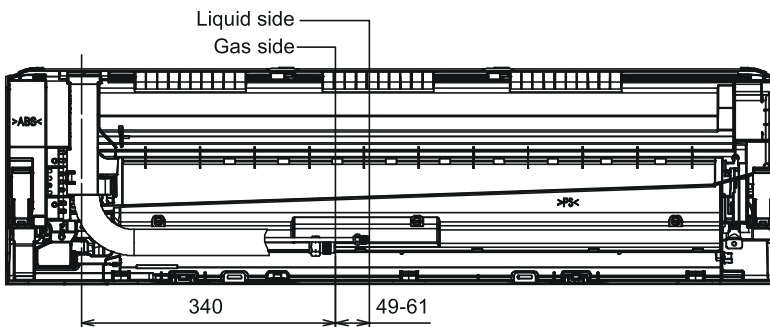

<Remote Control Holder>

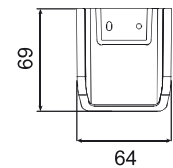

Relative position between the indoor unit and the installation plate <Front View>

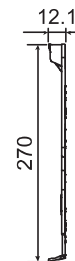
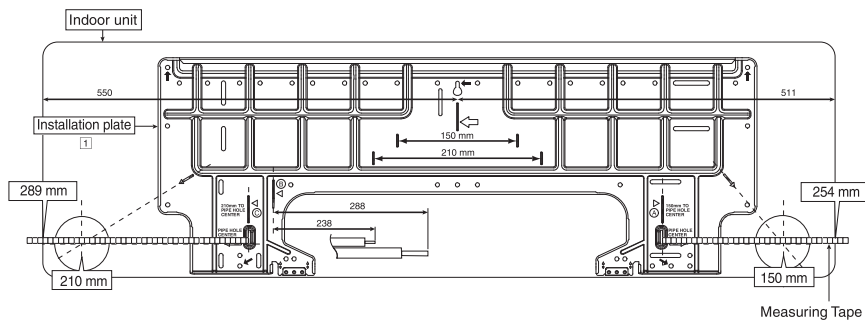

Unit: mm